

WIRE MANAGEMENT CORD CLIPS – ADHESIVE BACKED

ADHESIVE BACKED CORD CLIPS



- Easy hand installation.
- Install on clean, dry and smooth surfaces.
- Rounded corners and edges.
- Easy release paper protects adhesive until installation.

Material: Nylon, foamed backed adhesive tape

Colors: Natural, black (some models)

Note: Bundle diameter range reflects a tight bundle

PART NUMBER	PART NUMBER	PART NUMBER	PART NUMBER	PART NUMBER	PART NUMBER
8511-28-00	8511-29-00	8511-30-00	8511-31-00	8511-34-00	8511-36-00
MAXIMUM BUNDLE DIAMETER .156"	MAXIMUM BUNDLE DIAMETER .375"	MAXIMUM BUNDLE DIAMETER .375"	MAXIMUM BUNDLE DIAMETER .625"	MAXIMUM BUNDLE DIAMETER .450"	MAXIMUM BUNDLE DIAMETER .375"
AVAILABLE IN BLACK	AVAILABLE IN BLACK		AVAILABLE IN BLACK		

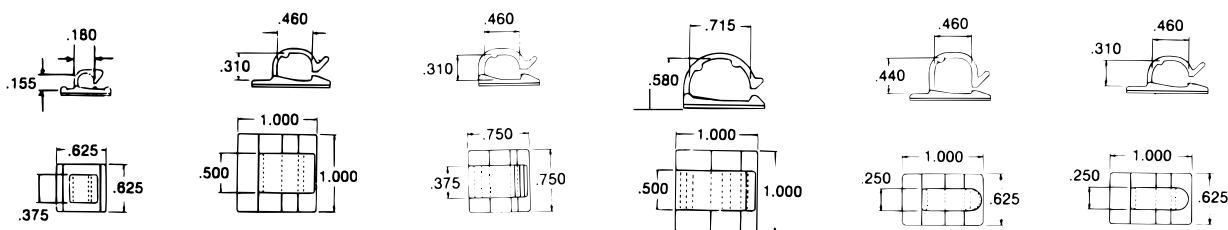

PART NUMBER	PART NUMBER	PART NUMBER	PART NUMBER	PART NUMBER	PART NUMBER	PART NUMBER
8511-37-00	8511-38-00	8511-54-00	8511-55-00	8511-55-01	8511-56-00	8511-46-00
MAXIMUM BUNDLE DIAMETER .250"	MAXIMUM BUNDLE DIAMETER .625"	MAXIMUM BUNDLE DIAMETER .156"	MAXIMUM BUNDLE DIAMETER .620"	MAXIMUM BUNDLE DIAMETER 1.00"	MAXIMUM BUNDLE DIAMETER .156"	MAXIMUM BUNDLE DIAMETER .156"
					SCREW HOLE #6 COUNTERSUNK	

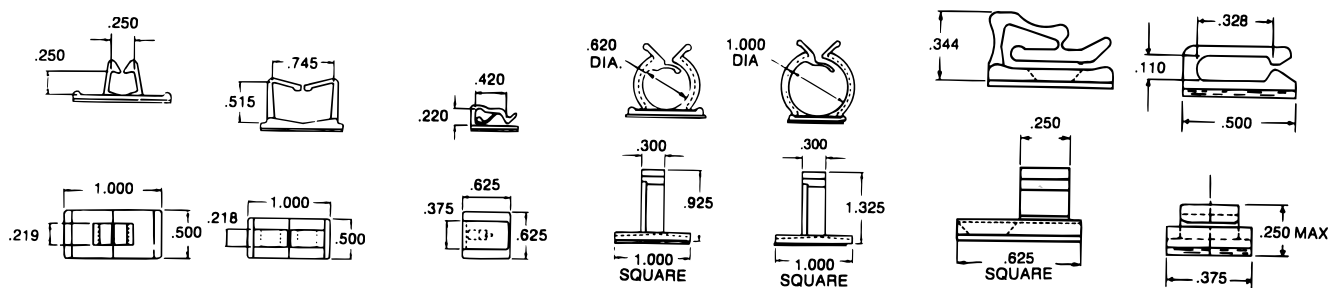

Try this part in
your application
Please call for samples.

800-747-7405

WIRE MANAGEMENT

CORD CLIPS – ADHESIVE BACKED

PART NUMBER	DIMENSIONS			MAXIMUM BUNDLE DIAMETER
	BLACK	A	B	
NARROW STYLE				
3888	.50"	.75"	.31"	.187"
3889	.50"	1.02"	.41"	.250"
3893	.50"	1.00"	.52"	.375"
3895	.50"	1.25"	.67"	.500"
3896	.63"	1.25"	.77"	.625"
3897	.75"	1.50"	.94"	.750"
WIDE STYLE				
3898	1.00"	.75"	.31"	.187"
3899	1.00"	1.02"	.41"	.250"
3900	1.00"	1.00"	.52"	.375"
3901	1.00"	1.25"	.67"	.500"
3902	1.25"	1.25"	.77"	.625"
3903	1.50"	1.50"	.94"	.750"

HEYCLIP™ ADHESIVE BACKED WIRE CLIPS

- Secure hold and quick release of bundle.
- Mounts on virtually any flat, clean and dry surface.
- 6 bundle sizes, 2 widths.

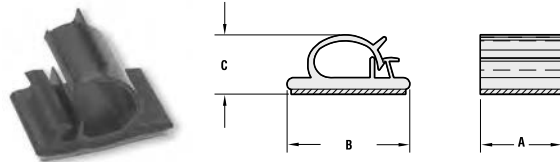

Material: Nylon with adhesive backed foam tape

Flammability Rating: 94V-2

HEYCLIP™ “J” STYLE–ADHESIVE BACKED

- Low-profile design with large adhesive base for greater holding power.
- Clear Material.
- 6 Bundle sizes.

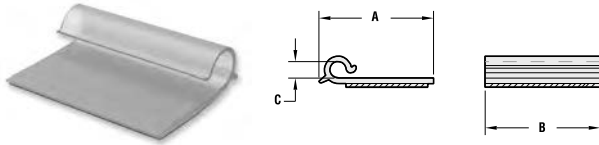

Material: PVC with adhesive backed foam tape.

PART NUMBER	DIMENSIONS			MAXIMUM BUNDLE DIAMETER
	CLEAR	A	B	
3839	1.00"	1.00"	.21"	.125"
3840	1.00"	1.25"	.27"	.187"
3841	1.00"	1.50"	.34"	.250"
3842	1.25"	1.75"	.42"	.312"
3843	1.25"	2.00"	.48"	.375"
3844	1.25"	2.25"	.64"	.500"

HEYCLIP™ “C” STYLE–ADHESIVE BACKED

- “Slide-in” bundle from the side.
- Large adhesive base.

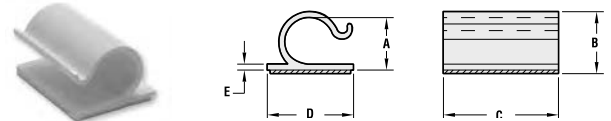

PART NUMBER	DIMENSIONS					MAXIMUM BUNDLE DIAMETER
	GRAY	A	B	C	D	
3794	.38"	.47"	1.00"	.75"	.05"	.500"

HEYCLIP™ “U” STYLE–ADHESIVE BACKED

- “Drop-In” bundle from the top.
- Compact design, for cable or tubing.

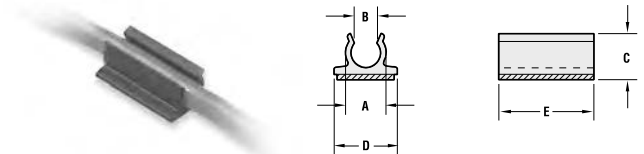

Material: PVC with adhesive backed foam tape.

PART NUMBER	DIMENSIONS					MAXIMUM BUNDLE DIAMETER
	BLACK	A	B	C	D	
3792	.19"	.15"	.27"	.42"	.62"	.250"

Try this part in your application
Please call for samples.

800-747-7405

WIRE MANAGEMENT CORD CLIPS – SCREW MOUNTED

- Infinitely reusable.
- “Twist” action interlocks ball ends.
- Can accommodate large bundle diameters.
- Won’t cut or abrade wires.

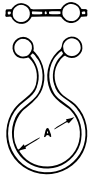

Material: Nylon
Color: Natural
Note: Bundle diameter range reflects a tight bundle

Style 1

STYLE 1 PART NUMBER	BUNDLE DIAMETER RANGE "A"
232-353509-03	.300" - .350"
232-353509-04	.400" - .480"
232-353509-07	.700" - .799"

- Can be fastened to a panel with a screw or a plasti-rivet.

PART NUMBER	DIMENSIONS				MOUNTING HOLE DIA. "E"	STYLE
	A	B	C	D		
220-414100-01	.640"	1.18"	1.87"	.250"	.281"	A
220-242400-01	.375"	.500"	1.32"	.300"	.157"	B
220-242400-02	.375"	.500"	1.32"	.300"	.210"	B

- Hinged element allows part to lift bundle off of the panel surface based on tension. 90° range.
- Easy to open and close purse lock design.

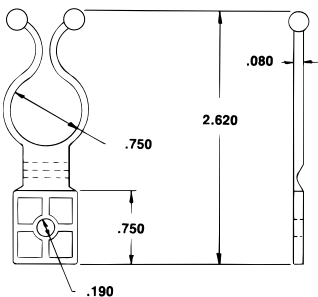

PURSE LOCK™ WIRE TIES

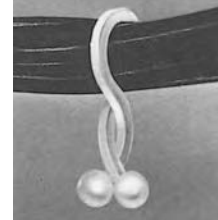

Style 2

“ADDED STRENGTH DESIGN”

STYLE 2 PART NUMBER	BUNDLE DIAMETER RANGE "A"
232-353509-09	.900" - 1.00"
232-353509-11	1.00" - 1.19"
232-353509-23	2.25" - 2.35"

SCREW DOWN CLIPS

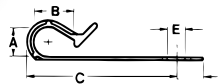
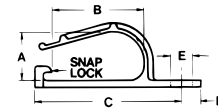

Style B

STANDOFF PURSE LOCK™ SCREW MOUNT – HINGED



PART NUMBER
232-454600-02

WIRE MANAGEMENT

CORD CLIPS – SCREW MOUNT, PUSH STYLE

NYLON CABLE CLAMPS

NON-CORROSIVE

- For clamping cable or tubing securely into place.
- Resists corrosion, salt water, weak acids, gasoline, alcohol, oil, grease and common solvents.
- Available in halogen free material in selected sizes.

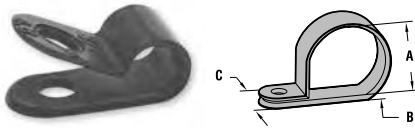

Material: Nylon
Certifications: UL #E-54523
Flammability Rating: 94V-2

Note: These clamps can be installed with many styles of non-corrosive panel fasteners found on pages 248 to 251.

PART NUMBER			DIMENSIONS			MOUNTING	
BLACK	NATURAL	HALOGEN FREE 94V-0	BUNDLE DIAMETER "A"	THICKNESS "B"	WIDTH "C"	HOLE DIAMETER	SCREW SIZE
LIGHT DUTY							
3362	3312	----	.125"	.050"	.375"	.170"	8
3363	3313	----	.187"				
3364	3314	----	.250"				
3365	3315	----	.312"				
3366	3316	----	.375"				
3367	3317	----	.437"			.203"	10
3368	3318	----	.500"				
3352	3302	3873	.125"				
3353	3303	3874	.187"				
3354	3304	3875	.250"				
3355	3305	3876	.312"				
3356	3306	3877	.375"				
3357	3307	3878	.437"				
3358	3308	3879	.500"				
HEAVY DUTY							
3372	3322	----	.125"	.060"	.500"	.203"	10
3373	3323	----	.187"				
3374	3324	----	.250"				
3375	3325	----	.312"				
3376	3326	----	.375"				
3377	3327	----	.437"				
3378	3328	----	.500"				
3379	3329	----	.562"				
3380	3330	----	.625"				
3381	3331	----	.687"				
3382	3332	----	.750"				
3383	3333	----	.812"				
3384	3334	----	.875"				
3390	3340	----	1.000"				
3392	3342	----	1.125"				
3393	3343	----	1.187"				
3394	3344	----	1.250"				
3396	3346	----	1.375"				
3398	3348	----	1.500"				

HEYCLIP™ SNAP-IN WIRE CLIPS

- Fast Installation.
- Secure hold and quick release of bundle.

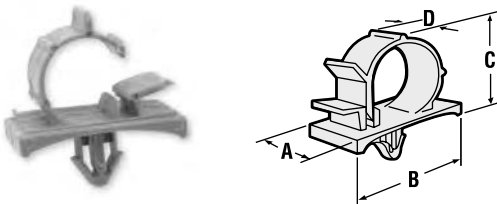

Material: Nylon
Flammability Rating: 94V-2

PART NUMBER	DIMENSIONS				MAXIMUM BUNDLE DIAMETER	MOUNTING	
	GRAY	A	B	C		D	HOLE DIAMETER
3845	.55"	1.00"	.39"	.38"	.187"	.250"	.020" - .080"
3846	.58"	1.00"	.44"	.41"	.250"		
3847	.65"	1.00"	.53"	.50"	.375"		
3848	.77"	1.19"	.72"	.60"	.500"		
3849	.88"	1.38"	.97"	.67"	.750"		
3853	1.37"	1.88"	1.30"	1.00"	1.00"		
3880	.55"	1.00"	.39"	.38"	.187"	.250"	.080" - .150"
3881	.58"	1.00"	.44"	.41"	.250"		
3882	.65"	1.00"	.53"	.50"	.375"		
3883	.77"	1.19"	.72"	.60"	.500"		
3884	.88"	1.38"	.97"	.67"	.750"		
3885	1.37"	1.88"	1.30"	1.00"	1.00"		

WIRE MANAGEMENT

CORD CLIPS – PUSH-IN

- Securely bundles wires and cords.
- “Snap-in” design.
- Insulates wires and holds them away from panels or moving parts.

STANDOFF PURSE LOCK PART NUMBER	DIMENSIONS			MOUNTING	
	MAXIMUM BUNDLE DIA. "A"	STANDOFF DISTANCE "B"	MAXIMUM INSTALLED HEIGHT "C"	HOLE DIAMETER	PANEL THICKNESS
232-120207-00*	.480"	.187"	1.287"	.187"	.015" - .090"
232-120207-10	.480"	.500"	1.600"	.187"	.015" - .090"
232-120207-20	.480"	.750"	1.850"	.187"	.015" - .090"
232-120209-00*	.600"	.187"	1.437"	.187"	.015" - .090"
232-120209-15	.600"	.625"	1.900"	.187"	.015" - .090"
232-120211-00*	.700"	.187"	1.637"	.187"	.015" - .090"

* Modified ball ends.

- Greater panel range and panel material flexibility.
- Securely bundles wires and cords.

STANDOFF PURSE LOCK CHRISTMAS TREE STYLE	DIMENSIONS			MOUNTING	
	MAXIMUM BUNDLE DIA. "A"	STANDOFF DISTANCE "B"	MAXIMUM INSTALLED HEIGHT "C"	HOLE DIAMETER	PANEL THICKNESS
232-160607-00	.480"	.125"	1.226"	.250"	.055" - .250"
232-160609-00	.600"	.125"	1.403"	.250"	.055" - .250"
232-160609-30	.600"	.937"	2.215"	.250"	.055" - .250"
1918-00*	1.20"	.250"	2.153"	.318"	.055" - .250"

* Modified ball ends.

- Adjustable ratcheting clip “squeezes” the bundle.
- Re-opens for adjustment/changes.
- Positive locking. Excellent for high vibration.

SNAP-IN CLIP PART NUMBER	DIMENSIONS					MOUNTING	
	MAXIMUM BUNDLE DIAMETER	A	B	C	D	HOLE DIAMETER	PANEL THICKNESS
1925-00	.406"	1.00"	.368"	.400"	.872"	.187"	.030" - .060"
1927-00	.575"	1.02"	.370"	.400"	.990"	.250"	.030" - .060"

- Fast installation into wide panel range.
- Re-opens for adjustment/changes.
- Positive locking. Excellent for high vibration.

SNAP-IN CLIP PART NUMBER	DIMENSIONS		MOUNTING	
	MAXIMUM BUNDLE DIAMETER	PRONG LENGTH "A"	HOLE DIAMETER	PANEL THICKNESS
1908-00	.472"	.410"	.250"	.020" - .197"
1903-00	.350"	.433"	.256"	.022" - .200"

Note: Listed dimensions are nominal

Material: (all items)

Nylon, natural or black.

STANDOFF PURSE LOCK™

Style 2
Flexible arm holds, single wires, small bundles, or large bundles

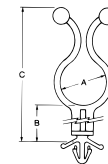

Style 1

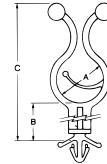

Style 2
232-120211-00
(Only)

INCH

NON-CORROSIVE

STANDOFF PURSE LOCK™ WITH CHRISTMAS TREE™ MOUNT

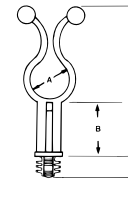

INCH

NON-CORROSIVE

SNAP-IN CLIP ADJUSTABLE BUNDLE

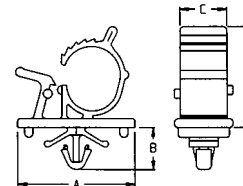

INCH

NON-CORROSIVE

SNAP-IN CLIP WITH CHRISTMAS TREE™ MOUNT

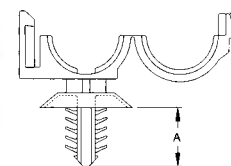

INCH

NON-CORROSIVE

WIRE MANAGEMENT

CORD CLIPS – PUSH-IN

TOP OPENING

- Allows maximum versatility for installation and bundle changes.

PART NUMBER	MAXIMUM BUNDLE DIAMETER "A"	MOUNTING	
		HOLE DIAMETER	PANEL THICKNESS
220-404000-01	.620"	.250"	.030" - .060"
220-646400-02	1.00"	.250"	.030" - .060"
220-646400-03*	1.38"	.250"	.075"
220-646400-04	1.50"	.250"	.075"
220-011005-00	1.00"	.250"	.030" - .125"
220-011006-00	.620"	.250"	.030" - .060"
220-011008-00	.500"	.250"	.030" - .125"

* Offset Prong

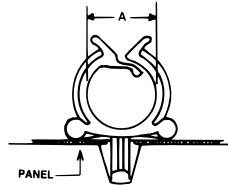

SNAP-IN CLIPS

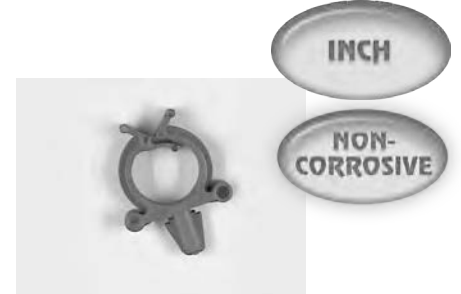

BOTTOM OPENING

- Captures the wire bundle (no escape).
- Load wire bundle, then insert the clip into the panel.

PART NUMBER	MAXIMUM BUNDLE DIAMETER "A"	MOUNTING	
		HOLE DIAMETER	PANEL THICKNESS
220-242400-09	.250"	.250"	.030" - .125"
220-242400-04	.375"	.250"	.030" - .125"
220-242400-06	.500"	.250"	.030" - .125"
220-242400-11*	.750"	.250"	.030" - .125"
220-242400-07	.750"	.250"	.030" - .125"

* High strength model

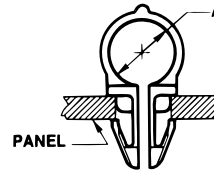

SNAP-IN CLIPS VARIOUS STYLES

- Quick insertion in to the panel.
- Wide variety of styles and bundle diameters.

INCH

NON-CORROSIVE

Try this part in your application
Please call for samples.

800-747-7405

PART NUMBER	BUNDLE AREA		MOUNTING		REFERENCE DRAWING
	A	B	HOLE DIA.	PANEL THICKNESS	
220-041600-00	.255"	.430"	.187"	.040" - .060"	A
220-120212-00	.515"	.432"	.187"	.015" - .094"	
220-031212-06	.515"	.750"	.187"	.015" - .070"	
220-120216-00	.875"	.385"	.187"	.015" - .094"	
220-031212-05	1.186"	.478"	.187"	.015" - .070"	
220-161213-00	.095"	.390"	.296"	.068" - .114"	B
220-031212-03	.515"	.437"	.187"	.015" - .070"	C
354-156009-00*	.110"	.327"	.156"	.040" - .160"	
220-031212-02	.281"	.287"	.187"	.015" - .070"	
1916-00	1.072"	.750"	.190"	.040" - .070"	D
220-121200-00	.280"	.400"	.250"	.125" - .180"	E
220-424200-05	.480"	1.462"	.250"	.035" - .140"	F

Note: Illustrations are general representations of the parts shapes. Please call for samples or a drawing of the part you desire.

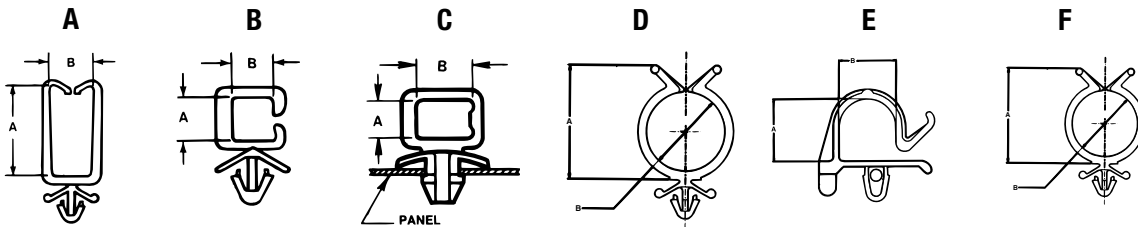

WIRE MANAGEMENT LIQUID TIGHT CONDUIT & TUBING

- Crush, pull and tamper resistant.
- Resists corrosion, abrasion, oil, water, acid, metal shavings, and rough environments.
- Smooth inside diameter for easy wire pulling.
- Approved for direct burial, submersible to 70 PSI.

TRADE SIZE	Heyco-Flex I PART NUMBER	OUTSIDE DIAMETER "A"	INSIDE DIAMETER "B"
3/8"	8430	.700" (17.8mm)	.494" (12.5mm)
1/2"	8431	.830" (21.2mm)	.632" (16.1mm)
3/4"	8432	1.04" (26.4mm)	.830" (21.1mm)
1"	8433	1.30" (33.1mm)	1.05" (26.8mm)
1 1/4"	8434	1.65" (41.8mm)	1.40" (35.4mm)
1 1/2"	8435	1.88" (47.8mm)	1.59" (40.3mm)
2"	8436	2.36" (59.9mm)	2.03" (51.6mm)

- Flexible construction, excellent for high vibration or flexing applications.
- Resists corrosion, oil and water.
- Smooth inside diameter for easy wire pulling.
- Submersible to 70 PSI.

TRADE SIZE	Heyco-Flex II PART NUMBER	OUTSIDE DIAMETER "A"	INSIDE DIAMETER "B"
1/4"	8449	.568" (14.4mm)	.395" (10.0mm)
3/8"	8450	.700" (17.8mm)	.494" (12.5mm)
1/2"	8451	.830" (21.2mm)	.632" (16.1mm)
3/4"	8452	1.04" (26.4mm)	.830" (21.1mm)
1"	8453	1.30" (33.1mm)	1.05" (26.8mm)
1 1/4"	8454	1.65" (41.8mm)	1.40" (35.4mm)
1 1/2"	8455	1.88" (47.8mm)	1.59" (40.3mm)
2"	8456	2.36" (59.9mm)	2.03" (51.6mm)



HEYCO-FLEX™ I LIQUID TIGHT CONDUIT

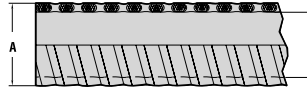

Material: PVC
Color: Gray
Flammability Rating: VW1
Certifications: #E-121095
 # LL-84578

HEYCO™ II LIQUID TIGHT TUBING

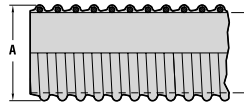

Material: PVC
Color: Black
Flammability Rating: VW1
Certifications: #E-121095
 # LL-84578

Heyco-Flex I & II can be used with Heyco Liquid Tight Connectors (pages 313 to 317), and Standard Mounting Brackets on page 312 as shown.

Cutting tool:
Part Number 8340



WIRE MANAGEMENT

WATER/AIR HOSE & TUBING

HEYCO-FLEX™ VI LIGHT DUTY EQUIPMENT HOSE



Size Range: 3/8" through 2"
Material: PVC
Color: Clear with white helix

- Suitable for light duty drainage, air, vacuum gravity feed and other equipment applications.
- Extremely flexible design.

Heyco-Flex VI PART NUMBER	INSIDE DIAMETER "A"	OUTSIDE DIAMETER "B"
8399	.375" (9.5mm)	.563" (14.3mm)
8440	.500" (12.7mm)	.688" (17.5mm)
8441	.625" (15.9mm)	.813" (20.7mm)
8442	.750" (19.1mm)	.969" (24.6mm)
8443	1.00" (25.4mm)	1.25" (31.8mm)
8444	1.25" (31.8mm)	1.50" (38.1mm)
8445	1.50" (38.1mm)	1.81" (46.0mm)
8446	2.00" (50.8mm)	2.38" (60.5mm)

HEYCO-FLEX™ VII BRAIDED TUBING

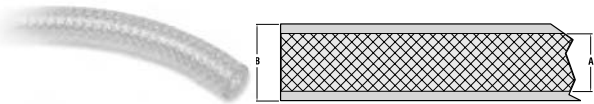

Size Range: 3/16" through 2"
Material: Reinforced PVC
Color: Clear with braiding

- For use in industrial applications: factory air lines, automation machinery, pneumatic lines and water mains/feeds.
- Suitable for high working pressure under harsh conditions.
- For use with barb style hose connectors.

Heyco-Flex VII PART NUMBER	INSIDE DIAMETER "A"	OUTSIDE DIAMETER "B"
8361	.180" (4.6mm)	.410" (10.4mm)
8362	.250" (6.4mm)	.440" (11.2mm)
8363	.310" (7.9mm)	.490" (12.4mm)
8364	.375" (9.5mm)	.590" (15.0mm)
8365	.500" (12.7mm)	.750" (19.1mm)
8366	.625" (15.9mm)	.875" (22.2mm)
8367	.750" (19.1mm)	1.02" (25.9mm)
8368	1.00" (25.4mm)	1.30" (33.0mm)
8369	1.25" (31.8mm)	1.63" (41.4mm)
8370	1.50" (38.1mm)	1.93" (49.0mm)
8371	2.00" (50.8mm)	2.50" (63.5mm)

STANDARD MOUNTING BRACKETS

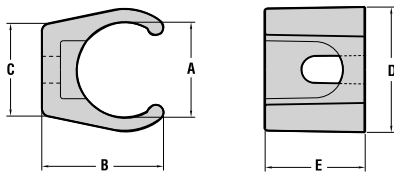

Dimensions excluding draft.

- Used to position standard size conduit, tubing and hose.

FITS CONDUIT TRADE SIZE	Heyco-Flex Mounting Brackets BLACK	DIMENSIONS				
		A	B	C	D	E
3/8"	1025	.71"	.91"	.69"	.91"	.75"
1/2"	1027	.84"	1.07"	.70"	1.05"	.75"
3/4"	1029	1.05"	1.26"	.73"	1.26"	.75"
1"	1031	1.32"	1.51"	.89"	1.52"	.75"

Material: Nylon
Flammability rating: 94V-2

WIRE MANAGEMENT LIQUID TIGHT CONNECTORS

For use with Heyco Brand and other non-metallic liquid tight conduit and tubing.

- Resistant to salt water, weak acids, gasoline, oil, alcohol, grease and common solvents. (nylon parts).
- Use provided locknut or thread into NPT hole.
- No disassembly required.
- Use of sealing washer may be required for wet applications.

HEYCO-FLEX™ STRAIGHT CONNECTORS - THREADED

Size range 1/4" – 2"



FITS CONDUIT TRADE SIZE	Heyco-Flex Straight Connector PART NUMBER		DIMENSIONS				MOUNTING	SEALING WASHER PART NUMBER
	BLACK	GRAY	MAXIMUM LENGTH "B"	THREAD LENGTH "C"	WRENCHING NUT THICKNESS "D"	WRENCHING FLATS "E"	CLEARANCE HOLE "A"	
	1/4"	8398	----	1.13" (28.7mm)	.440" (11.2mm)	.218" (5.5mm)	.87" (22.1mm)	
3/8"	8400	8401	1.33" (33.8mm)	.625" (15.9mm)	.250" (6.3mm)	1.30" (33mm)	.875" (22.2mm)	3260
1/2"	8402	8403	1.33" (33.8mm)	.625" (15.9mm)	.250" (6.3mm)	1.30" (33mm)	.875" (22.2mm)	3260
3/4"	8404	8405	1.41" (35.8mm)	.625" (15.9mm)	.250" (6.3mm)	1.52" (38.6mm)	1.109" (28.2mm)	3261
1"	8406	8407	1.47" (37.3mm)	.781" (19.8mm)	.250" (6.3mm)	1.875" (47.6mm)	1.375" (35mm)	3262
1 1/4"	8638*	8639*	2.12" (53.8mm)	.715" (18.2mm)	.250" (6.3mm)	----	1.688" (42.9mm)	----
1 1/2"	8640*	8641*	2.42" (61.5mm)	.680" (17.3mm)	.250" (6.3mm)	----	1.938" (49.2mm)	----
2"	8642*	8643*	2.49" (63.2mm)	.680" (17.3mm)	.250" (6.3mm)	----	2.375" (60.3mm)	----

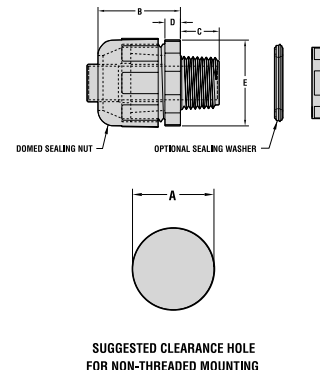

* Not registered to listed certifications.

Note:

Black parts – Black Nylon Locknut

Gray parts – O-Ring and Metal Locknuts

Material:

(1/4" – 1") Nylon

(1 1/4" – 2") PVC

Flammability Rating: 94V-2 (Nylon only)

Certifications: UL #E-28430

SP # LR-84579

and #LR-81067

- Easy to assemble, simply "snap-in" to panel hole.
- Resistant to salt water, weak acids, gasoline, oil, alcohol, grease and common solvents.
- No disassembly required.
- Suitable for indoor or outdoor use.

HEYCO-FLEX™ STRAIGHT CONNECTORS - SNAP-IN

Size range 1/4" – 1"

FITS CONDUIT TRADE SIZE	Heyco-Flex "Snap-In" Connector PART NUMBER BLACK	DIMENSIONS				MOUNTING	
		MAXIMUM LENGTH "B"	BODY LENGTH "C"	WRENCHING NUT THICKNESS "D"	WRENCHING FLATS "E"	MOUNTING HOLE DIAMETER "A"	PANEL THICKNESS
		1/4"	8382*	1.50" (38.1mm)	.500" (12.7mm)	.218" (5.5mm)	.87" (22.1mm)
3/8"	8384	2.00" (50.8mm)	.625" (15.9mm)	.250" (6.3mm)	1.33" (33.7mm)	.875" (22.2mm)	.032" - .125" (.8mm - 3.2mm)
1/2"	8386	2.00" (50.8mm)	.625" (15.9mm)	.250" (6.3mm)	1.33" (33.7mm)	.875" (22.2mm)	.032" - .125" (.8mm - 3.2mm)
3/4"	8338	2.03" (51.6mm)	.625" (15.9mm)	.250" (6.3mm)	1.56" (39.7mm)	1.090" (27.7mm)	.032" - .125" (.8mm - 3.2mm)
1"	8390	2.25" (57.1mm)	.781" (19.8mm)	.250" (6.3mm)	1.81" (46.0mm)	1.375" (35mm)	.032" - .125" (.8mm - 3.2mm)

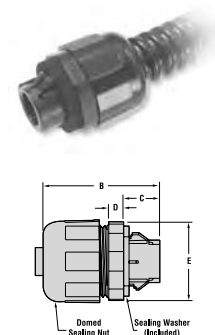

UL only. file # E-121095.

Material: Nylon

Flammability Rating: 94V-2

Certifications: UL #E-28430

SP # LR-84579

and #LR-81067

™ HEYCO Products, Inc.

WIRE MANAGEMENT LIQUID TIGHT CONNECTORS

HEYCO-FLEX™ III STRAIGHT CONNECTOR



Size range 1/4" – 1"

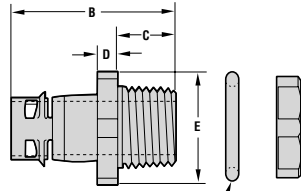

(Optional)
"O" Ring

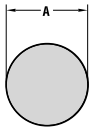

SUGGESTED CLEARANCE HOLE
FOR NON-THREADED MOUNTING

- Easy permanent assembly: push tubing over ferrule until tubing "clicks" in place.
- For use in wet or dry locations.
- Low-profile, clean appearance.
- Optional "O"-ring, yields a liquid tight system.

FITS CONDUIT TRADE SIZE	Heyco-Flex III Straight Connector PART NUMBER		PRIMARY DIMENSIONS			MOUNTING		O-RING PART NUMBER
	BLACK 94V-2	HALOGEN FREE BLACK 94V-0	MAXIMUM LENGTH "B"	BODY THREAD LEN- GTH "C"	WRENCHING NUT THICKNESS "D"	CLEARANCE HOLE "A"	THREADED HOLE	
	1/4"	9140	8469	1.54" (39.1mm)	.44" (11.3mm)	.20" (5.1mm)	.492" (12.5mm)	
3/8"	9146	8470	1.72" (43.7mm)	.62" (15.9mm)	.20" (5.1mm)	.875" (22.2mm)	1/2" NPT	1995
1/2"	9147	8471	1.72" (43.7mm)	.62" (15.9mm)	.20" (5.1mm)	.875" (22.2mm)	1/2" NPT	1995
3/4"	9148	8472	1.84" (46.7mm)	.62" (15.9mm)	.20" (5.1mm)	1.109" (28.2mm)	3/4" NPT	1996
1"	9149	8473	1.99" (50.5mm)	.78" (19.8mm)	.20" (5.1mm)	1.375" (35mm)	1" NPT	1997

Material:

Flammability Rating:

Certifications:

Nylon

See chart above.

UL # E121095, NSF # LR-84579 (halogen free only)

HEYCO-FLEX™ SWEEP CONNECTOR - THREADED



Size range 3/8" – 2"

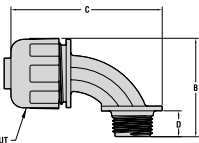

DOMED SEALING NUT



OPTIONAL SEALING WASHER

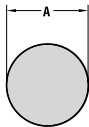

SUGGESTED CLEARANCE HOLE
FOR NON-THREADED MOUNTING

- Smooth internal surfaces for easier wire installation around corner angles.
- Use provided locknut, or thread into NPT hole.
- No disassembly required.
- Use of sealing washer may be required for wet applications.

FITS CONDUIT TRADE SIZE	Heyco-Flex Sweep Connector PART NUMBER		DIMENSIONS			MOUNTING		SEALING WASHER PART NUMBER
	BLACK	GRAY	MAXIMUM HEIGHT "B"	MAXIMUM LENGTH "C"	THREAD LENGTH "D"	CLEARANCE HOLE "A"	THREADED HOLE	
3/8"	8423	8424	1.98" (50.3mm)	2.91" (73.9mm)	.52" (13.2mm)	.875" (22.2mm)	1/2" NPT	3260
1/2"	8425	8426	1.98" (50.3mm)	2.91" (73.9mm)	.52" (13.2mm)	.875" (22.2mm)	1/2" NPT	3260
3/4"	8427	8428	2.29" (58.2mm)	3.17" (80.5mm)	.52" (13.2mm)	1.109" (28.2mm)	3/4" NPT	3261
1"	8412	8413	2.83" (71.9mm)	3.96" (100.6mm)	.69" (17.5mm)	1.375" (35mm)	1" NPT	3262
1 1/4"	8652*	8653*	4.35" (110.5mm)	4.71" (119.6mm)	.64" (16.3mm)	1.688" (42.9mm)	1 1/4" NPT	----
1 1/2"	8654*	8655*	4.46" (113.3mm)	4.69" (119.1mm)	.66" (16.8mm)	1.938" (49.2mm)	1 1/2" NPT	----
2"	8656*	8657*	4.87" (123.7mm)	5.31" (134.9mm)	.67" (17.0mm)	2.375" (60.3mm)	2" NPT	----

* Not registered to listed certifications.

Material:

(3/8" – 1 ") Nylon

(1 1/4 – 2 ") PVC

Flammability Rating: 94V-2

Certifications: UL #E-28430

NSF # LR-84579

and #LR-81067

WIRE MANAGEMENT

"QUICK TWIST" CONNECTORS

- UL approved when used with Heyco-Flex™ II tubing.
- Low piece part and installed cost.
- One piece design with smooth internal surfaces for easy wire routing.
- No tools required.

"QUICK TWIST" CONNECTOR STRAIGHT, SNAP-IN

Size range 1/4" – 1"

FITS CONDUIT TRADE SIZE	"Quick Twist" Connector Straight - "Snap-In" Style PART NUMBER		DIMENSIONS				MOUNTING	
			OVERALL LENGTH "B"	BODY LENGTH "C"	WRENCHING NUT "D"	WRENCHING FLATS "E"	MOUNTING HOLE DIAMETER "A"	PANEL THICKNESS
	BLACK	GRAY						
1/4"	8515	8516	1.33" (33.8mm)	.344" (8.7mm)	.090" (2.3mm)	.750" (19mm)	.540" (13.7mm)	.045" - .140" (1.1mm - 3.6mm)
3/8"	8485	8486	1.38" (35mm)	.391" (9.9mm)	.090" (2.3mm)	1.00" (25.4mm)	.875" (22.2mm)	.045" - .140" (1.1mm - 3.6mm)
1/2"	8490	8491	1.38" (35mm)	.391" (9.9mm)	.090" (2.3mm)	1.00" (25.4mm)	.875" (22.2mm)	.045" - .140" (1.1mm - 3.6mm)
3/4"	8495	8496	1.50" (38mm)	.390" (9.9mm)	.090" (2.3mm)	1.25" (31.8mm)	1.09" (27.8mm)	.045" - .140" (1.1mm - 3.6mm)

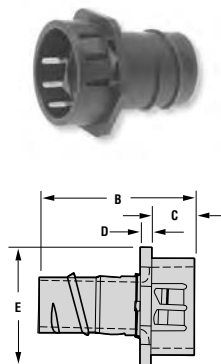

Material: Nylon
Flammability Rating: 94V-2

Certifications: UL #E121095

- UL approved when used with Heyco-Flex™ II tubing
- Low piece part and installed cost.
- One piece design with smooth internal surfaces for easy wire routing around corners.
- No tools required.

"QUICK TWIST" CONNECTOR SWEEP, SNAP-IN

Size range 3/8" – 3/4"

FITS CONDUIT TRADE SIZE	"Quick Twist" Connector Sweep - "Snap-In" Style PART NUMBER		DIMENSIONS				MOUNTING	
			MAXIMUM HEIGHT "B"	MAXIMUM LENGTH "C"	BODY LENGTH "D"	FLANGE DIAMETER "E"	MOUNTING HOLE DIAMETER	PANEL THICKNESS
	BLACK	GRAY						
3/8"	8500	8501	1.75" (44.6mm)	2.75" (69.8mm)	.390" (9.9mm)	1.23" (31.2mm)	.875" (22.2mm)	.045" - .140" (1.1mm - 3.6mm)
1/2"	8505	8506	1.75" (44.6mm)	2.75" (69.8mm)	.390" (9.9mm)	1.23" (31.2mm)	.875" (22.2mm)	.045" - .140" (1.1mm - 3.6mm)
3/4"	8510	8511	1.97" (50mm)	3.08" (78.3mm)	.390" (9.9mm)	1.50" (38.1mm)	1.09" (27.8mm)	.045" - .140" (1.1mm - 3.6mm)

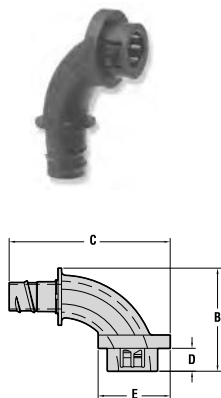

Material: Nylon
Flammability Rating: 94V-2

Certifications: UL #E121095

Accessories – Finishing Collars (Black or Gray) All Quick Twist Models



To Order: Add suffix "FC" to any "Quick Twist" series part number

Note: Not available in 1/4" size

WIRE MANAGEMENT

"QUICK TWIST" CONNECTORS

"QUICK TWIST" CONNECTOR STRAIGHT, THREADED



Size Range
1/4" – 3/4"

- UL approved with Heyco-Flex™ I conduit.
- Installs in NPT threaded hole or through clearance hole with locknut (order separately).
- All nylon construction resists salt water, weak acids, gasoline, oil grease and common solvents.
- Easy permanent assembly by "twisting" tubing on to the connector.

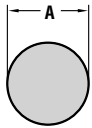
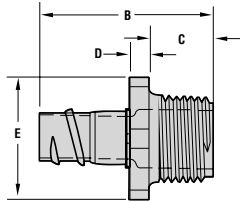

SUGGESTED CLEARANCE HOLE
FOR NON-THREADED MOUNTING

FITS CONDUIT TRADE SIZE	"Quick Twist" Connector Straight - NPT Threaded PART NUMBER		DIMENSIONS				MOUNTING	
	BLACK	GRAY	MAXIMUM LENGTH "B"	THREAD LENGTH "C"	WRENCHING NUT "D"	WRENCHING FLATS "E"	CLEARANCE HOLE DIAMETER	THREADED HOLE
	1/4"	8517	8518	1.56" (39.6mm)	.465" (11.8mm)	.200" (5.1mm)	.750" (19mm)	----
3/8"	8487	8488	1.72" (44.6mm)	.625" (15.9mm)	.200" (5.1mm)	1.18" (30mm)	.875" (22.2mm)	3/8-NPT-90R
1/2"	8493	8494	1.72" (44.6mm)	.625" (15.9mm)	.200" (5.1mm)	1.18" (30mm)	.875" (22.2mm)	1/2-NPT-90R
3/4"	8497	8498	1.84" (46.7mm)	.625" (15.9mm)	.200" (5.1mm)	1.37" (34.8mm)	1.109" (28.2mm)	3/4-NPT-90R

Material: Nylon
Flammability Rating: 94-V

Certifications: #E28430

"QUICK TWIST" CONNECTOR SWEEP, THREADED



Size Range
3/8" – 3/4"

- UL approved with Heyco-Flex™ I conduit.
- Installs in NPT threaded hole or through clearance hole with locknut (order separately).
- All nylon construction resists salt water, weak acids, gasoline, oil grease and common solvents.
- Easy permanent assembly by "twisting" tubing on to the connector.

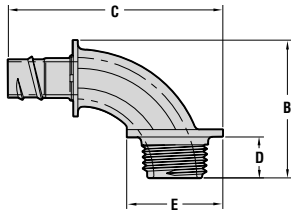

FITS CONDUIT TRADE SIZE	"Quick Twist" Connector Sweep - NPT Threaded PART NUMBER		DIMENSIONS				MOUNTING	
	BLACK	GRAY	MAXIMUM HEIGHT "B"	MAXIMUM LENGTH "C"	THREAD LENGTH "D"	FLANGE DIAMETER "E"	CLEARANCE HOLE DIAMETER	THREADED HOLE
	3/8"	8502	8503	1.75" (44.6mm)	2.75" (69.8mm)	.521" (13.2mm)	1.23" (31.2mm)	.875" (22.2mm)
1/2"	8507	8508	1.75" (44.6mm)	2.75" (69.8mm)	.521" (13.2mm)	1.23" (31.2mm)	.875" (22.2mm)	1/2-NPT-90R
3/4"	8512	8513	2.11" (53.5mm)	3.09" (78.3mm)	.530" (13.5mm)	1.50" (38.1mm)	1.109" (28.2mm)	3/4-NPT-90R

Material: Nylon
Flammability Rating: 94-V

Certifications: #E28430

Locknuts:
Order separately
for clearance
hole applications.



THREAD TYPE AND SIZE	BLACK	GRAY
3/8 NPT	8461	8462
1/2 NPT	8463	8464
3/4 NPT	8465	8466

WIRE MANAGEMENT LIQUID TIGHT FITTINGS

- For liquid tight passage of cable or tubing.
- Suitable for NEMA 4 and NEMA 6 enclosures.

LIQUID TIGHT STRAIGHT-THRU FITTINGS



CABLE DIAMETER RANGE	Liquid Tight Straight-Thru Fittings PART NUMBER		DIMENSIONS				MOUNTING	
	BLACK	GRAY	MAXIMUM LENGTH "B"	THREAD LENGTH "C"	WRENCHING NUT THICKNESS "D"	WRENCHING FLATS "E"	CLEARANCE HOLE "A"	DIRECT THREAD SIZE
PG HUB THREADING (LOCKNUT INCLUDED)								
.064" - .210"	3444	3445	1.17"	.33"	.20"	.59"	.492"	PG 7
.114" - .250"	3207	3208	1.17"	.33"	.20"	.59"	.492"	
.069" - .187"	3446	3447	1.30"	.34"	.20"	.75"	.599"	PG 9
.181" - .312"	3210	3211	1.30"	.34"	.20"	.75"	.599"	
.069" - .250"	3448	3449	1.46"	.39"	.20"	.86"	.733"	PG 11
.230" - .395"	3213	3214	1.46"	.39"	.20"	.86"	.733"	
.170" - .470"	3216	3217	1.53"	.41"	.20"	.95"	.804"	PG 13.5
.230" - .547"	3219	3220	1.66"	.45"	.23"	1.05"	.886"	PG 16
.250" - .490"	3454	3455	1.87"	.52"	.23"	1.30"	1.115"	PG 21
.450" - .709"	3222	3223	1.87"	.52"	.23"	1.30"	1.115"	
.590" - 1.00"	3225	3226	2.23"	.59"	.28"	1.66"	1.470"	PG 29
.787" - 1.02"	M3206	M3205	2.52"	.51"	.32"	2.09"	1.850"	PG 36
.875" - 1.26"	M3204	M3203	2.52"	.51"	.32"	2.09"	1.850"	
.984" - 1.22"	3218	----	2.64"	.51"	.36"	2.36"	2.125"	PG 42
1.26" - 1.50"	3212	----	2.64"	.51"	.36"	2.36"	2.125"	
1.14" - 1.38"	3283	----	2.72"	.55"	.36"	2.56"	2.335"	PG 48
1.48" - 1.73"	3281	----	2.72"	.55"	.36"	2.56"	2.335"	
NPT HUB THREADING (ORDER LOCKNUT FOR PANEL MOUNTING - SEE BELOW)								
.065" - .210"	M4514	M4515	1.28"	.45"	.21"	.63"	.540"	1/4 NPT
.115" - .250"	M4516	M4517	1.28"	.45"	.21"	.63"	.540"	3/8 NPT
.069" - .187"	3458	3459	1.49"	.53"	.20"	.75"	.670"	
.181" - .312"	3228	3229	1.49"	.53"	.20"	.75"	.670"	1/2 NPT
.170" - .470"	3231	3232	1.72"	.62"	.20"	.95"	.875"	
.230" - .547"	3200	3201	1.83"	.62"	.23"	1.05"	.875"	3/4 NPT
.250" - .485"	3460	3461	1.97"	.63"	.23"	1.30"	1.068"	
.450" - .709"	3234	3235	1.97"	.63"	.23"	1.30"	1.068"	1 NPT
.472" - .787"	8439	3227	2.42"	.75"	.28"	1.65"	1.375"	
.590" - 1.00"	8437	8438	2.42"	.75"	.28"	1.65"	1.375"	1 1/4 NPT
.787" - 1.02"	M4522	M4523	2.69"	.78"	.30"	2.05"	1.680"	
.875" - 1.26"	M4524	M4525	2.69"	.78"	.30"	2.05"	1.680"	
METRIC HUB THREADING (LOCKNUT INCLUDED)								
1.7mm-5.6mm	M4330	M4331	29.5mm	8.1mm	5.3mm	16mm	12mm	M12
2.9mm-6.4mm	M4332	M4333	29.5mm	8.1mm	5.3mm	16mm	12mm	
1.7mm-4.7mm	M4334	M4335	31.8mm	8.1mm	5.3mm	21mm	16mm	M16
2.7mm-7.9mm	M4336	M4337	31.8mm	8.1mm	5.3mm	21mm	16mm	
2.4mm-6.6mm	M4338	M4339	37.8mm	10.4mm	5.3mm	24.9mm	20mm	M20
4.3mm-11.9mm	M4340	M4341	37.8mm	10.4mm	5.3mm	24.9mm	20mm	
6.4mm-12.3mm	M4342	M4343	48mm	13.2mm	6.4mm	33mm	25mm	M24
12.3mm-18mm	M4344	M4345	48mm	13.2mm	6.4mm	33mm	25mm	
12.4mm-20mm	M4346	M4347	56.6mm	14.7mm	7.6mm	43.9mm	32mm	M32
15mm-25.4mm	M4348	M4349	56.6mm	14.7mm	7.6mm	43.9mm	32mm	
20mm-25.9mm	M4350	M4351	60.7mm	12.2mm	7.6mm	52.1mm	40mm	M40
22mm-32mm	M4352	M4353	60.7mm	12.2mm	7.6mm	52.1mm	40mm	

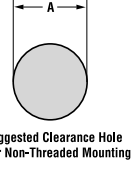
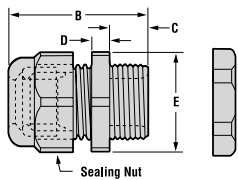

- Use fitting with the smallest maximum diameter for best results.

Material: Nylon with TPE Gland

Color: Black, Gray

Certifications:

- UL #E 51579 (shaded)
- UL #E 51579 (non-shaded)
- CSA # LR-93876 (all)

Locknuts:

Order separately for NPT Hub parts, if a lockout is desired.



THREAD TYPE AND SIZE	BLACK	GRAY
3/8 NPT	8461	8462
1/2 NPT	8463	8464
3/4 NPT	8465	8466
1 NPT	8467	8468

WIRE MANAGEMENT, LIQUID TIGHT FITTINGS

WIRE MANAGEMENT LIQUID TIGHT FITTINGS

LIQUID TIGHT PIGTAIL™ FITTINGS

- Flexible “Pigtail” extender prevents sharp bends; extends cable life.
- Suitable for NEMA 4 and NEMA 6 enclosures.

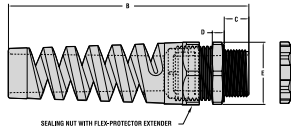

Specifications - (both styles)

Material: Nylon with TPE or Buna-N-Gland

Certifications:

- UL #E-51579 (shaded)
- RU #E-51579 (non-shaded)
- SP #LR-93876 (all)

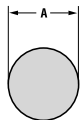

Mounting Hole

Suggested Clearance Hole For Non-Threaded Mounting

CABLE DIAMETER RANGE	Liquid Tight Pigtail Fittings PART NUMBER		DIMENSIONS				MOUNTING	
	BLACK	GRAY	MAXIMUM LENGTH "B"	THREAD LENGTH "C"	WRENCHING NUT THICKNESS "D"	WRENCHING FLATS "E"	CLEARANCE HOLE "A"	DIRECT THREAD SIZE
PG HUB THREADING (LOCKNUT INCLUDED)								
.064" - .210"	3464	3465	2.44"	.33"	.20"	.59"	.492"	PG 7
.114" - .250"	3237	3238	2.44"	.33"	.20"	.59"	.492"	
.069" - .187"	3466	3467	2.77"	.34"	.20"	.75"	.599"	PG 9
.181" - .312"	3240	3241	2.77"	.34"	.20"	.75"	.599"	
.069" - .260"	3468	3469	3.44"	.39"	.20"	.86"	.733"	PG 11
.230" - .395"	3243	3244	3.44"	.39"	.20"	.86"	.733"	
.170" - .470"	3246	3247	3.88"	.41"	.20"	.95"	.804"	PG 13.5
.230" - .547"	3249	3250	4.36"	.45"	.23"	1.05"	.886"	PG 16
.250" - .485"	3478	3479	5.03"	.52"	.23"	1.30"	1.115"	PG 21
.450" - .709"	3245	3248	5.03"	.52"	.23"	1.30"	1.115"	
NPT HUB THREADING (ORDER LOCKNUT FOR PANEL MOUNTING - SEE BELOW)								
.069" - .187"	3474	3475	2.97"	.53"	.20"	.75"	.670"	3/8 NPT
.181" - .312"	3254	3255	2.97"	.53"	.20"	.75"	.670"	
.170" - .470"	3251	3252	4.09"	.62"	.20"	.95"	.875"	1/2 NPT
.230" - .547"	3266	3267	4.54"	.62"	.23"	1.05"	.875"	
.250" - .485"	3462	3463	5.14"	.63"	.23"	1.30"	1.068"	3/4 NPT
.450" - .709"	3239	3242	5.14"	.63"	.23"	1.30"	1.068"	
METRIC HUB THREADING (LOCKNUT INCLUDED)								
1.7mm-5.6mm	M4396	M4397	62mm	8.1mm	5.3mm	16mm	12mm	M12
2.9mm-6.4mm	M4398	M4399	62mm	8.1mm	5.3mm	16mm	12mm	
1.7mm-4.7mm	M4400	M4401	70.4mm	8.1mm	5.3mm	21.1mm	16mm	M16
2.7mm-7.9mm	M4402	M4403	70.4mm	8.1mm	5.3mm	21.1mm	16mm	
2.4mm-6.6mm	M4404	M4405	98.8mm	10.4mm	5.3mm	24.9mm	20mm	M20
4.3mm-11.9mm	M4406	M4407	98.8mm	10.4mm	5.3mm	24.9mm	20mm	
6.4mm-12.3mm	M4408	M4409	128mm	13.2mm	6.4mm	33mm	25mm	M25
12.3mm-18mm	M4410	M4411	128mm	13.2mm	6.4mm	33mm	25mm	

LIQUID TIGHT RIGHT ANGLE FITTINGS

- Molded open for easy installation.
- Snap-shut to bend the cable without damage.
- Suitable for NEMA 6P enclosures.

WIRE MANAGEMENT, LIQUID TIGHT FITTINGS

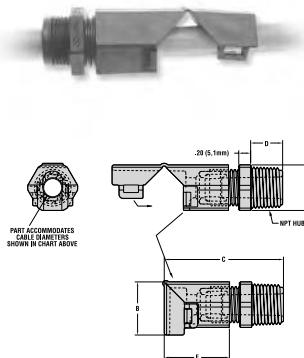

CABLE DIAMETER RANGE	Liquid Tight Right Angle Fittings PART NUMBER		DIMENSIONS				MOUNTING		
	BLACK	GRAY	RIGHT ANGLE HEIGHT "B"	MAXIMUM LENGTH (CLOSED) "C"	THREAD LENGTH "D"	SEALING NUT LENGTH "E"	WRENCH FLATS "F"	CLEARANCE HOLE "A"	DIRECT THREAD SIZE
PG HUB THREADING (LOCKNUT INCLUDED)									
.064" - .210"	M8530	M8531	.69"	1.53"	.33"	.86"	.59"	.492"	PG 7
.114" - .250"	M8532	M8533	.69"	1.53"	.33"	.86"	.59"	.492"	
.069" - .187"	M8534	M8535	.88"	1.77"	.34"	1.07"	.75"	.599"	PG 9
.181" - .312"	M8536	M8537	.88"	1.77"	.34"	1.07"	.75"	.599"	
.078" - .260"	M8538	M8539	.99"	1.99"	.39"	1.23"	.86"	.733"	PG 11
.230" - .395"	M8540	M8541	.99"	1.99"	.39"	1.23"	.86"	.733"	
.170" - .470"	M8542	M8543	1.06"	2.20"	.41"	1.38"	.95"	.804"	PG 13.5
NPT HUB THREADING (ORDER LOCKNUT FOR PANEL MOUNTING - SEE BELOW)									
.069" - .187"	M8560	M8561	.88"	1.96"	.53"	1.07"	.75"	.670"	3/8 NPT
.181" - .312"	M8562	M8563	.88"	1.96"	.53"	1.07"	.75"	.670"	
.170" - .470"	M8564	M8565	1.06"	2.40"	.62"	1.38"	.95"	.875"	1/2 NPT
METRIC HUB THREADING (LOCKNUT INCLUDED)									
1.7mm-5.6mm	M4448	M4449	17.5mm	38.8mm	8.1mm	21.8mm	16mm	12mm	M12
2.9mm-6.4mm	M4450	M4451	17.5mm	38.8mm	8.1mm	21.8mm	16mm	12mm	
1.7mm-4.7mm	M4452	M4453	22.4mm	45mm	8.1mm	27.2mm	21mm	16mm	M16
2.7mm-7.9mm	M4454	M4455	22.4mm	45mm	8.1mm	27.2mm	21mm	16mm	
2.4mm-6.6mm	M4456	M4457	26.9mm	56.4mm	10.4mm	35.1mm	24.9mm	20mm	M20
4.3mm-11.9mm	M4458	M4459	26.9mm	56.4mm	10.4mm	35.1mm	24.9mm	20mm	

Locknuts (NPT Hub) – see chart on opposite page

WIRE MANAGEMENT STRAIN RELIEF BUSHINGS

For Round Cables

STRAIGHT-THRU STRAIN RELIEF BUSHINGS

WILL FIT THESE CABLES			PART NUMBER		MOUNTING			BODY LENGTH "C"
UL DESIGNATION	AWG CONDUCTORS	APPROXIMATE DIAMETER	BLACK	WHITE	MAXIMUM PANEL THICKNESS	HOLE SIZE		
						DIAMETER "A"	ANTI-ROTATION "B"	
AWM	----	.125" - .187"	1060	1061	.062"	.375"	.330"	.406"
SV & SVT	18/2	.220" - .245"	1157	1158	.062"	.500"	.450"	.438"
SAME AS ABOVE, EXCEPT PANEL THICKNESS			1140	1141	.100"			
SV & SVT	18/2	.250"	1150	1151	.062"	.500"	.450"	.438"
	18/3	.255"				.500" - .515"		
HPD	18/2	.270"				.500"		
	16/2	.290"			.100"	SAME AS ABOVE		
SAME AS ABOVE, EXCEPT PANEL THICKNESS			1147	1148	.156"			
SV & SVT	18/3	.255"	1137	1138	.100"	.500"	.450"	.438"
HPD	16/2	.290"						
SJ, SJT & SJO	18/2	.300"	1184	1185	.090"	.500"	.465"	.438"
SJ, SJT & SJO	18/2	.300"	1217	1218	.062"	.625"	.550"	.578"
SAME AS ABOVE, EXCEPT PANEL THICKNESS			1210	1211	.125"	SAME AS ABOVE		
SJ, SJT & SJO	16/2	.325"	1200	1201	.062"	.625"	.550"	.578"
	18/3	.330"						
	14/2	.350"						
	16/3	.355"						
	18/4	.360"						
SAME AS ABOVE, EXCEPT PANEL THICKNESS			1207	1208	.125"	SAME AS ABOVE		
SJ, SJT & SJO	18/2	.300"	1214	1215	.156"	.625"	.550"	.678"
	16/2	.325"				.656"		
	18/3	.330"				.656"		
	16/3	.355"				.687"		
SJT	18/4	.360"						
	14/3	.370"						
S & ST	18/2	.390"	1244	1245	.062"	.750"	.660"	.750"
	18/3	.405"				.750" - .781"		
	16/2	.405"						
	16/3	.430"						
SAME AS ABOVE, EXCEPT PANEL THICKNESS			1237	1238	.125"	SAME AS ABOVE		
SJ, SJT & SJO	16/2	.325"	1240	1241	.125"	.875"	.770"	.750"
	18/3	.330"						
	14/2	.350"						
	16/3	.355"						
	18/4	.360"						
SJT	14/3	.370"						
	12/3	.425"						
S & ST	18/2	.390"	1247	1248	.125"	.875"	.770"	.750"
	18/3	.405"						
	16/2	.405"						
	16/3	.430"						
SAME AS ABOVE, EXCEPT PANEL THICKNESS			1250	1251	.200"	SAME AS ABOVE		
SJT	12/3	.425" - .475"	1497	1498	.125"	.875"	.840"	.812"
S & ST	14/2	.530"	1254	1255	.062"	.875"	.840"	.828"
	14/3	.560"						
	12/2	.600"						
SAME AS ABOVE, EXCEPT PANEL THICKNESS			1260	1261	.125"	SAME AS ABOVE		.812"
			1274	1275	.187"	SAME AS ABOVE		
S	12/2	.600"	1287	1288	.281"	1.093"	1.00"	1.00"
	12/3	.635"				1.125"		
	10/2	.640"				1.093"		
S, ST & SO	10/3	.690"				1.187"		



- Protects the cord by absorbing pull, push and twist forces.
- Securely anchors, insulates and protects the cable at the chassis entry point.
- Assembly tools are available, please call.

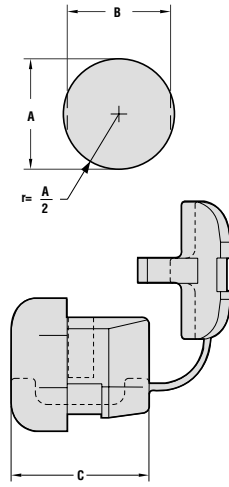

Material: Nylon
Certifications: UL # E-15331
 # LR-8919
Flammability Rating: 94V-2

Try this part in your application
 Please call for samples.
800-747-7405

WIRE MANAGEMENT, STRAIN RELIEFS

WIRE MANAGEMENT STRAIN RELIEF BUSHINGS

STRAIGHT-THRU STRAIN RELIEF BUSHINGS

For Flat Cables



- Protects the cord by absorbing pull, push and twist forces.
- Securely anchors, insulates and protects the cable at the chassis entry point.
- Assembly tools are available, please call.



Material: Nylon
Certifications: # E-15331
 # LR-8919
Flammability Rating: 94V-2

WILL FIT THESE CABLES			PART NUMBER		MOUNTING			BODY LENGTH "C"
UL DESIGNATION	AWG CONDUCTORS	APPROXIMATE SIZE	BLACK	WHITE	MAXIMUM PANEL THICKNESS	HOLE SIZE		
							DIAMETER "A"	ANTI-ROTATION "B"
CLOCK SPT-1	20/2	.09" X .18"	1017	1018	.062"	.375"	.345"	.406"
	18/2	.11" X .21"						
SAME AS ABOVE, EXCEPT PANEL THICKNESS			1034	1035	.125"			
SPT-1	18/2	.12" X .22"	1074	1075	.040"	.437"	.390"	.406"
			1077	1078	.062"			
			1104	1105	.100"			
			1094	1095	.156"			
SAME AS ABOVE, EXCEPT PANEL THICKNESS								
SPT-1 HPN	18/3	.12" X .30"	1120	1121	.062"	.500"	.465"	.406"
	18/2	.15" X .28"						
SAME AS ABOVE, EXCEPT PANEL THICKNESS			1117	1118	.100"			
SAME AS ABOVE, EXCEPT PANEL THICKNESS			1127	1128	.156"			
SPT-1	18/3	.12" X .30"	1114	1115	.095"	.500"	.460"	.500"
SPT-2 & HPN	18/2	.15" X .28"						
	16/2	.16" X .30"						
HPN	18/3	.15" X .34"						
SAME AS ABOVE, EXCEPT PANEL THICKNESS			1124	1125	.187"	SAME AS ABOVE		
SPT-2	18/3	.15" X .40"	1170	1171	.062"	.562"	.530"	.609"
	16/3	.16" X .41"						
SPT-3	18/2	.19" X .35"	1167	1168	.125"	.562"	.530"	.609"
	16/2	.20" X .37"						
SAME AS ABOVE, EXCEPT PANEL THICKNESS								
SPT-2 & HPN	16/3	.16" X .37"	1174	1175	.125"	.562"	.530"	.609"
	18/3	.15" X .40"						
	16/3	.16" X .41"						
SPT-2	18/3	.15" X .40"	1484	1485	.125"	.560"	.730"	.672"
	16/3	.16" X .41"						
	18/2	.19" X .35"						
	18/3	.19" X .39"						
SPT-3	16/2	.20" X .37"	1504	1505	.125"	.750"	.875"	.781"
	16/3	.20" X .43"						
	14/2	.24" X .42"						
SPT-3	14/2	.24" X .42"	1517	1518	.125"	.875"	.840"	.813"
	14/3	.24" X .51"						
	12/2	.29" X .51"						
	12/3	.29" X .65"						
SPT-3	12/3	.32" X .65"	1497	1498	.125"	.875"	.840"	.813"
	10/3							
300 OHM*		.06" X .40"	1814	1815	.100"	.375"	.625"-.640"	.469"
SPT-1	18/3	.12" X .30"				.375"-.390"		
	18/3	.15" X .40"				.415"-.422"		
SPT-2	16/3	.16" X .41"				.422"-.437"		
	SAME AS ABOVE, EXCEPT PANEL THICKNESS			1804	1805	.156"	SAME AS ABOVE	

Try this part in your application
 Please call for samples.
800-747-7405

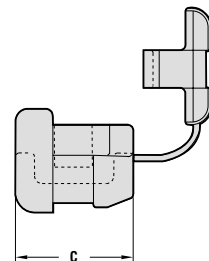
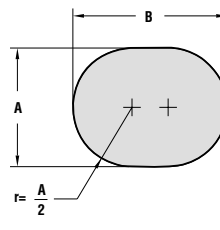
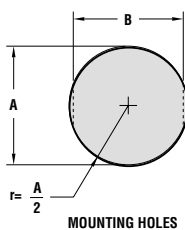

WIRE MANAGEMENT STRAIN RELIEF BUSHINGS

For Flat or Round Cables

**LOCKIT™
STRAIN RELIEF BUSHINGS**

WILL FIT THESE CABLES			PART NUMBER		MOUNTING	
UL DESIGNATION	AWG CONDUCTORS	APPROXIMATE SIZE	BLACK	WHITE	HOLE SIZE	PANEL THICKNESS RANGE
<i>FOR FLAT CABLES</i>						
SPT-1	18/2	.12" X .22"	1829	1830	.453" X .512" (11.5mm X 13mm)	.032" - .099" (.8mm-2.5mm)
	18/3	.12" X .30"				
SPT-2 & HPN	18/2	.15" X .28"				
	16/2	.16" X .30"				
HPN	16/3	.16" X .37"				
SPT-2	18/3	.15" X .40"				
	16/3	.16" X .41"				
SPT-3	18/2	.19" X .35"	1834	1835	.689" X .689" (17.5mm X 17.5mm)	.032" - .157" (.8mm - .4mm)
	18/3	.19" X .39"				
	16/2	.20" X .37"				
	16/3	.20" X .43"				
14/2	.24" X .42"					
SPT-3	16/3	.032" X .099"	1847	----	.453" X .630" (11.5mm X 16mm)	.032" - .099" (.8mm-2.5mm)
HPN	18/3	.380" X .105"				
SPT-2	18/2	.135" X .270"				
<i>FOR ROUND CABLES</i>						
SV	18/2	.220" DIA.	1832	1833	.453" X .512" (11.5mm X 13mm)	.032" - .099" (.8mm-2.5mm)
	18/3	.250" DIA.				
SVT	18/2	.245" DIA.				
	18/3	.255" DIA.				
HPD	18/2	.270" DIA.				
	16/2	.290" DIA.				
SJ	18/2	.300" DIA.	1836	1837	.689" X .689" (17.5mm X 17.5mm)	.032" - .157" (.8mm - 4mm)
	16/2	.315" DIA.				
	18/3	.320" DIA.				
SJO	16/2	.325" DIA.				
	18/3	.330" DIA.				
SJT	14/2	.350" DIA.				
	16/3	.355" DIA.				
	18/4	.360" DIA.				
SJT	14/2	.355" DIA.	1848	----	.689" X .689" (17.5mm X 17.5mm)	.032" - .157" (.8mm-4mm)
STO	16/3	.390" DIA.				
SEOW-A	16/4	.420" DIA.				



Flat Cable

- Strain reliefs self-lock onto the cable.
- May be assembled off-line and inserted into the chassis later.
- Protects the cord by absorbing push, pull and twisting forces.
- Assembly tools are available, please call.



Round Cable

Material: Nylon

Certifications: # E-15331

LR-8919

Flammability Rating: 94V-2

Part Numbers
1829, 1830, 1832, 1833

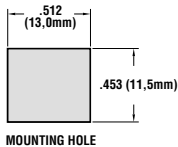

Part Numbers
1834, 1835, 1836, 1837, 1848

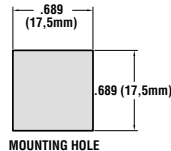

Part Number
1847

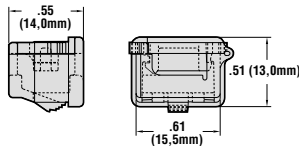
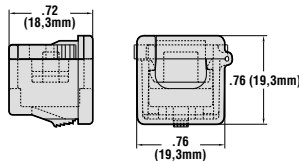
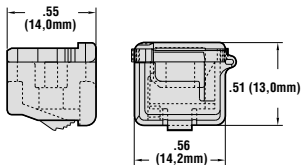
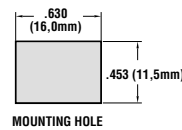

WIRE MANAGEMENT STRAIN RELIEF BUSHINGS

RIGHT ANGLE STRAIN RELIEF BUSHINGS

For Flat or Round Cables



Flat Cable

- Saves space by allowing the cable to exit parallel to the chassis.
- Acts as a back bumper.
- Protects the cord by absorbing push, pull and twisting forces.
- Securely anchors, insulates and protects the cable at the chassis entry point.
- Assembly tools are available, please call.



Round Cable

Material: Nylon
Certifications: UL # E-15331
 SP # LR-8919
Flammability Rating: 94V-2

WILL FIT THESE CABLES			PART NUMBER BLACK	MOUNTING			HEAD LENGTH "C"	BODY LENGTH "D"
UL DESIGNATION	AWG CONDUCTORS	APPROXIMATE SIZE		MAXIMUM PANEL THICKNESS	HOLE SIZE			
					DIAMETER "A"	ANTI-ROTATION "B"		
<i>FOR FLAT CABLES</i>								
SPT-1	18/2	.12" X .22"	1354	.062"	.437"	.390"	.234"	.500"
SPT-1	18/3	.12" X .30"	1361	.040"	.500"	.450"	.390"	.687"
SPT-2 HPN	18/2	.15" X .28"						
	16/2	.16" X .30"	1364	.100"				
SAME AS ABOVE, EXCEPT PANEL THICKNESS								
SPT-2	18/3	.15" X .40"	1384	.125"	.562"	.525"	.500"	.859"
SPT-3	18/2	.19" X .35"						
HPN	16/2	.20" X .37"						
	16/3	.16" X .37"						
SPT-2	18/3	.15" X .40"	1424	.080"	.560"	.730"	.406"	.812"
	16/3	.16" X .41"						
	18/2	.19" X .35"						
SPT-3	18/3	.19" X .39"						
	16/2	.20" X .37"						
	16/3	.20" X .43"	1434	.125"	SAME AS ABOVE			
SAME AS ABOVE, EXCEPT PANEL THICKNESS								
SPT-3	16/2	.20" X .37"	1454	.125"	.750"	.875"	.484"	.937"
	16/3	.20" X .43"						
	14/2	.24" X .42"						
	14/3	.24" X .51"						
SPT-3	14/2	.24" X .42"	1464	.125"	.875"	.840"	.500"	.968"
	14/3	.24" X .51"						
	12/2	.29" X .51"						
	12/3	.29" X .65"						
SPT-3	10/3	.32" X .66"	1440	.125"	1.093"	1.00"	.734"	1.437"
<i>FOR ROUND CABLES</i>								
SV & SVT	18/2	.250" DIA.	1374	.100"	.500"	.450"	.390"	.687"
	18/3	.265" DIA.			.500" - .515"			
HPD	18/2	.270" DIA.			.500"			
	16/2	.290" DIA.			.500" - .515"			
SJ, SJT & SJO	18/2	.300" DIA.	1320	.125"	.625"	.550"	.562"	.968"
	16/2	.325" DIA.						
	18/3	.330" DIA.						
	16/3	.355" DIA.						
SJ, SJT & SJO	16/2	.325" DIA.	1327	.125"	.625"	.550"	.562"	.968"
	18/3	.330" DIA.						
	16/3	.355" DIA.						
SAME AS ABOVE, EXCEPT PANEL THICKNESS								
SJT	18/4	.360" DIA.	1397	.125"	.750"	.660"	.640"	1.093"
	14/3	.370" DIA.						
S & ST	18/2	.390" DIA.						
	18/3	.405" DIA.						
	16/2	.405" DIA.						
	16/3	.430" DIA.						

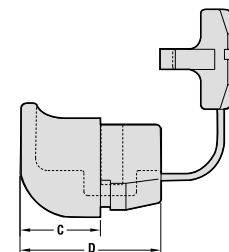
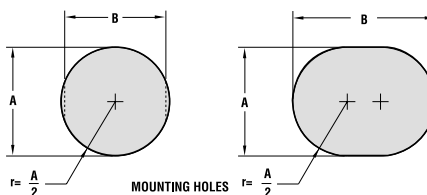

WIRE MANAGEMENT STRAIN RELIEF BUSHINGS

For Flat or Round Cables

BELL-MOUTH STRAIN RELIEF BUSHINGS

WILL FIT THESE CABLES			PART NUMBER		MOUNTING			HEAD LENGTH "C"	BODY LENGTH "D"
UL DESIGNATION	AWG CONDUCTORS	APPROXIMATE SIZE	BLACK	WHITE	MAXIMUM PANEL THICKNESS	HOLE SIZE			
							DIAMETER "A"	ANTI-ROTATION "B"	
<i>FOR FLAT CABLES</i>									
CLOCK	18/3	.09" X .18"	1020	1021	.062"	.375"	.330"	.375"	.625"
SPT-2	18/2	.11" X .21"							
SPT-1	18/2	.12" X .22"	1080	1081	.062"	.437"	.390"	.375"	.625"
SPT-1	18/3	.12" X .30"	1108	1109	.062"	.500"	.465"	.406"	.703"
SPT-2 & HPN	18/2	.15" X .28"				.500"-.515"			
HPN	16/2	.16" X .30"	1229	1230	.125"	.625"	.550"	.406"	.813"
	18/3	.15" X .34"							
	16/3	.16" X .37"							
SPT-2	16/2	.16" X .30"	1220	1221	.125"	.625"	.550"	.421"	.813"
	16/3	.16" X .41"							
<i>FOR ROUND CABLES</i>									
SV & SVT	18/2	.250" DIA.	1143	1144	.062"	.500"	.450"	.406"	.688"
	18/3	.255" DIA.				.500"-.515"			
HPD	18/2	.270" DIA.	1226	1227	.125"	.625"	.550"	.421"	.813"
	16/2	.290" DIA.							
SJ, SJT & SJO	18/2	.300" DIA.	1232	1233	.125"	.625"	.550"	.421"	.813"
SJ, SJT & SJO	16/2	.315" DIA.	1223	1224	.062"	.625"	.550"	.421"	.813"
	18/3	.320" DIA.							
	14/2	.350" DIA.							
	16/3	.355" DIA.	1220	1221	.125"	.625"	.550"	.421"	.813"
	18/4	.360" DIA.							
SAME AS ABOVE, EXCEPT PANEL THICKNESS									



- Flared end prevents sharp bending and assures longer cable life.

Material: Nylon

Certifications:

UL #E-15331

UL #LR-8919

Flammability Rating: 94V-2

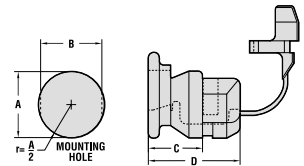

* See Bell mouth for materials and certifications

For Flat or Round Cables

PIGTAIL™ STRAIN RELIEF BUSHINGS

WILL FIT THESE CABLES			PART NUMBER		MOUNTING			EXTENSION LENGTH "C"	BODY LENGTH "D"
UL DESIGNATION	AWG CONDUCTORS	APPROXIMATE SIZE	BLACK	WHITE	MAXIMUM PANEL THICKNESS	HOLE SIZE			
							DIAMETER "A"	ANTI-ROTATION "B"	
<i>FOR FLAT CABLES</i>									
SPT-1	18/3	.12" X .30"	1541	1542	.062"	.500"	.465"	1.72"	1.98"
SPT-2 & HPN	18/2	.15" X .28"							
<i>FOR ROUND CABLES</i>									
SV & SVT	18/2	.250" DIA.	1590	1591	.062"	.500"	.450"	1.70"	1.98"
	18/3	.255" DIA.				.500"-.515"			
HPD	18/2	.270" DIA.	1593	1594	.125"	.625"	.550"	1.72"	2.11"
	16/2	.290" DIA.							
SAME AS ABOVE, EXCEPT PANEL THICKNESS									
SJ, SJT & SJO	18/2	.300" DIA.	1596	1597	.062"	.625"	.550"	1.72"	2.11"
SAME AS ABOVE, EXCEPT PANEL THICKNESS			1602	1603	.125"	.625"	.550"	1.72"	2.11"
SJ, SJT & SJO	16/2	.315" DIA.	1599	1600	.062"	.625"	.550"	1.72"	2.11"
	18/3	.320" DIA.							
	14/2	.350" DIA.							
	16/3	.355" DIA.							
	18/4	.360" DIA.	1605	1606	.125"	.625"	.550"	1.72"	2.11"
SAME AS ABOVE, EXCEPT PANEL THICKNESS									
SJT	18/4	.360" DIA.	1611	1612	.125"	.750"	.660"	2.16"	2.60"
	14/3	.370" DIA.							
	18/2	.390" DIA.							
S & ST	18/3	.405" DIA.	1613	1614	.125"	.750"	.660"	2.16"	2.60"
	16/2	.405" DIA.							
	16/3	.430" DIA.							



- "Pigtail" end prevents sharp bending and assures long cable life

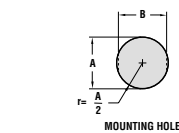
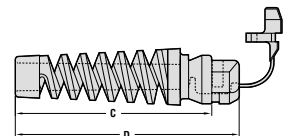

™ HEYCO Products, Inc.

WIRE MANAGEMENT BUSHINGS

SNAP BUSHINGS

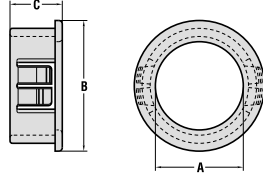

- Converts raw holes to smooth, neat, insulated holes.
- “Snaps” into the hole with fingertip pressure.
- Wide range of hole sizes.
- Locking fingers grip panel at thickness up to and including listed maximum.
- Brass colors for lamps available as standards in select sizes.
- Custom colors available for volume applications.

PART NUMBER		DIMENSIONS			MOUNTING	
BLACK	WHITE	INSIDE DIAMETER "A"	HEAD DIAMETER "B"	OVERALL HEIGHT "C"	MAXIMUM PANEL THICKNESS	HOLE DIAMETER
2003*	2004*	.125"	.312"	.312"	.040"	.250"
2000*	2001*	.125"	.312"	.312"	.062"	.250"
2010*	2011*	.187"	.375"	.312"	.062"	.312"
2020	2021	.187"	.468"	.406"	.125"	.375"
2030	2031	.250"	.468"	.406"	.125"	.375"
2017*	2018*	.281"	.468"	.406"	.172"	.375"
2038	2039	.270"	.531"	.406"	.125"	.437"
2043	2044	.312"	.531"	.406"	.125"	.437"
2042	2037	.243"	.531"	.406"	.125"	.437"
2058	2059	.250"	.578"	.406"	.125"	.500"
2049	2050	.312"	.578"	.406"	.125"	.500"
2053	2054	.391"	.578"	.406"	.125"	.500"
2060	2061	.312"	.656"	.406"	.125"	.562"
2063	2064	.391"	.656"	.406"	.125"	.562"
2066	2067	.437"	.656"	.406"	.125"	.562"
2075	2078	.250"	.718"	.406"	.125"	.625"
2075	2078	.250"	.718"	.406"	.125"	.625"
2075	2078	.250"	.718"	.406"	.125"	.625"
2075	2078	.250"	.718"	.531"	.125"	.625"
2083	2084	.500"	.781"	.406"	.125"	.687"
2086	2087	.562"	.781"	.406"	.125"	.687"
2090	2091	.391"	.843"	.406"	.125"	.750"
2092	2099	.500"	.843"	.406"	.125"	.750"
2093	2094	.562"	.843"	.406"	.125"	.750"
2096	2097	.609"	.843"	.406"	.125"	.750"
2840*	2841*	.625"	.828"	.531"	.250"	.750"
2100	2101	.562"	.890"	.406"	.125"	.812"
2103	2104	.625"	.890"	.406"	.125"	.812"

PART NUMBER		DIMENSIONS			MOUNTING	
BLACK	WHITE	INSIDE DIAMETER "A"	HEAD DIAMETER "B"	OVERALL HEIGHT "C"	MAXIMUM PANEL THICKNESS	HOLE DIAMETER
2110	2111	.375"	.953"	.453"	.125"	.875"
2113	2114	.437"	.953"	.453"	.125"	.875"
2116	2117	.500"	.953"	.453"	.125"	.875"
2120	2121	.562"	.953"	.453"	.125"	.875"
2123	2124	.625"	.953"	.453"	.125"	.875"
2126	2127	.687"	.953"	.453"	.125"	.875"
2140	2141	.766"	1.125"	.453"	.125"	1.000"
2160	2161	.812"	1.218"	.453"	.125"	1.125"
2163	2164	.875"	1.218"	.453"	.125"	1.125"
2166	2167	.937"	1.218"	.453"	.125"	1.125"
2182	2183	.937"	1.312"	.453"	.125"	1.187"
2198	2199	.937"	1.359"	.453"	.125"	1.250"
2201	2202	1.000"	1.310"	.453"	.125"	1.250"
2207	2208	.875"	1.468"	.453"	.125"	1.375"
2210	2211	1.000"	1.468"	.453"	.125"	1.375"
2233	2234	1.062"	1.609"	.453"	.125"	1.500"
2236	2237	1.125"	1.609"	.453"	.125"	1.500"
2240	2241	1.312"	1.609"	.453"	.125"	1.500"
2300	2301	1.375"	1.875"	.453"	.125"	1.750"
2400	2401	1.640"	2.125"	.453"	.125"	2.000"
2406	----	1.750"	2.125"	.453"	.125"	2.000"
2415	2416	1.813"	2.350"	.720"	.250"	2.093"
2417	2418	1.860"	2.480"	.720"	.250"	2.250"
2420	2421	1.970"	2.660"	.720"	.250"	2.500"
2461	2462	2.470"	3.160"	.720"	.250"	3.000"
2407	2408	2.812"	3.660"	.720"	.250"	3.375"
2470	2471	2.940"	3.660"	.720"	.250"	3.500"
2479	2480	3.460"	4.170"	.720"	.250"	4.000"
2409	2410	4.375"	5.219"	.720"	.250"	5.000"
2484	2485	5.375"	6.219"	.720"	.250"	6.000"

* Single chassis design, call for drawing

METRIC SIZES AVAILABLE, SEE PAGE 326.

Material: Nylon

Certifications: # E-15331

LR-8919

Flammability Rating: 94V-2

WIRE MANAGEMENT BUSHINGS

SHORTY BUSHINGS

- Same as snap bushing, but with minimal internal protrusion.

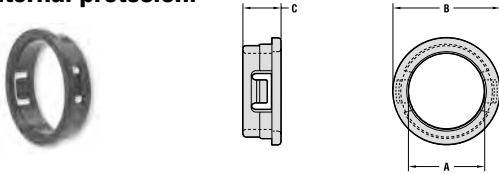

PART NUMBER		DIMENSIONS			MOUNTING	
BLACK	WHITE	INSIDE DIAMETER "A"	HEAD DIAMETER "B"	OVERALL HEIGHT "C"	MAXIMUM PANEL THICKNESS	HOLE DIAMETER
2800	2801	.125"	.250"	.234"	.062"	.187"
2859	2860	.125"	.281"	.234"	.062"	.218"
2853	2854	.218"	.343"	.234"	.062"	.281"
2810	2811	.250"	.375"	.234"	.062"	.312"
2856	2857	.218"	.406"	.250"	.062"	.343"
2803	2804	.250"	.437"	.250"	.062"	.375"
2806	2807	.281"	.468"	.250"	.062"	.406"
2813	2814	.312"	.500"	.250"	.062"	.437"
2817	2818	.343"	.530"	.250"	.062"	.468"
2820	2821	.375"	.562"	.250"	.062"	.500"
2824	2825	.406"	.593"	.250"	.062"	.531"
2833	2834	.468"	.656"	.250"	.062"	.593"
2827	2828	.500"	.703"	.250"	.062"	.625"
2836	2837	.625"	.828"	.250"	.062"	.750"
2844	2845	.625"	.859"	.250"	.062"	.781"
2850	2851	.750"	.937"	.250"	.062"	.875"
2847	2848	.879"	1.060"	.250"	.062"	1.000"

OPEN/CLOSE BUSHINGS

- Split design allows side entry and encirclement of pre-assembled harnesses and tubing.
- Can be used on holes already containing a cable assembly or tubing.

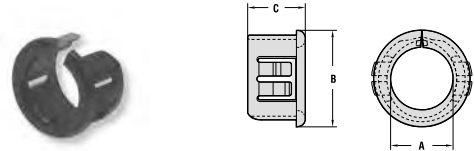

PART NUMBER		DIMENSIONS			MOUNTING	
BLACK		INSIDE DIAMETER "A"	HEAD DIAMETER "B"	OVERALL HEIGHT "C"	MAXIMUM PANEL THICKNESS	HOLE DIAMETER
2865		.265"	.421"	.390"	.125"	.375"
2867		.312"	.500"	.406"	.125"	.437"
2871		.312"	.562"	.406"	.125"	.500"
2869		.390"	.640"	.406"	.125"	.562"
2872		.453"	.687"	.406"	.125"	.625"
2873		.546"	.796"	.406"	.125"	.750"
2874		.671"	.921"	.406"	.125"	.875"
2878		.812"	1.047"	.406"	.125"	1.000"
2879		.875"	1.156"	.406"	.125"	1.093"
2881		1.046"	1.343"	.406"	.125"	1.250"
2882		1.171"	1.468"	.406"	.125"	1.375"
2883		1.250"	1.578"	.421"	.125"	1.500"

SHORTY UNIVERSAL BUSHING

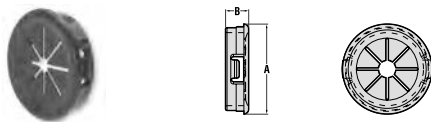

PART NUMBER		DIMENSIONS			MOUNTING	
BLACK		MAXIMUM INSIDE DIAMETER	HEAD DIAMETER "A"	OVERALL HEIGHT "B"	MAXIMUM PANEL THICKNESS	HOLE DIAMETER
2861		.437"	.729"	.250"	.062"	.625"
2862		.500"	.859"	.250"	.062"	.750"
2863		.560"	.937"	.250"	.062"	.875"

UNIVERSAL BUSHING

- Flexible shutters adjust to support any shape.
- Absorbs vibration, cushions and insulates cables, tubing, or shafts.

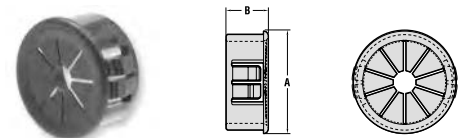

PART NUMBER		DIMENSIONS			MOUNTING	
BLACK		MAXIMUM INSIDE DIAMETER	HEAD DIAMETER "A"	OVERALL HEIGHT "B"	MAXIMUM PANEL THICKNESS	HOLE DIAMETER
2055		.312"	.600"	.385"	.125"	.500"
2077		.437"	.718"	.406"	.125"	.625"
2089		.500"	.844"	.390"	.125"	.750"
2106		.500"	.890"	.390"	.125"	.812"
2119		.562"	.937"	.453"	.125"	.875"
2137		.750"	1.063"	.453"	.125"	1.000"
2157		.812"	1.156"	.453"	.125"	1.093"
2184		1.000"	1.490"	.453"	.125"	1.375"
2213		1.062"	1.610"	.450"	.125"	1.500"

Specifications (All Models)

Material: Nylon
Certifications: UL # E-15331
 SP # LR-8919
Flammability Rating: 94V-2

WIRE MANAGEMENT BUSHINGS

DOUBLE INSULATED BUSHINGS

- Extra internal sleeve covers entire inside diameter.
- "No-slag" design.
- Large radius exit hole.

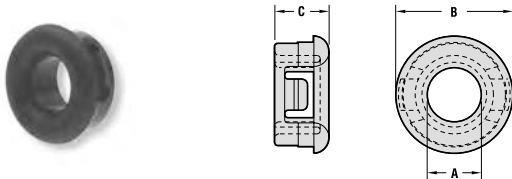

PART NUMBER		DIMENSIONS			MOUNTING	
BLACK	WHITE	INSIDE DIAMETER "A"	HEAD DIAMETER "B"	OVERALL HEIGHT "C"	MAXIMUM PANEL THICKNESS	HOLE DIAMETER
2514	2515	.250"	.562"	.265"	.062"	.500"

Material: Nylon

Certifications: #E-15331
 # LR-8919

METRIC SNAP BUSHINGS



- Standard metric hole sizes for the popular snap bushing line.

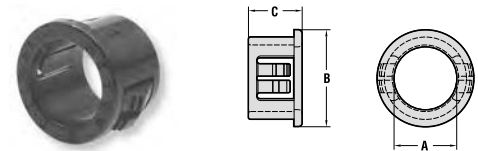

PART NUMBER		DIMENSIONS			MOUNTING	
BLACK	WHITE	INSIDE DIAMETER "A"	HEAD DIAMETER "B"	OVERALL HEIGHT "C"	MAXIMUM PANEL THICKNESS	HOLE DIAMETER
2142	2143	12mm	18.5mm	10.3mm	2.5mm	16mm
2144	2145	15mm	22.6mm	10.3mm	2.5mm	20mm
2146	2147	19mm	27.8mm	11.5mm	2.5mm	25mm
2148	2149	26mm	34.9mm	11.5mm	2.5mm	32mm

Flammability Rating: 94V-2

SNUB BUSHINGS

- Provides insulation plus light strain relief.
- Suitable for 1/8" – 1/4" diameter cable or tubing.

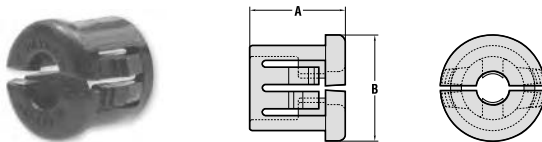

APPROXIMATE CABLE DIAMETER ACCOMMODATED	PART NUMBER	DIMENSIONS		MOUNTING	
	BLACK	HEAD DIAMETER "A"	OVERALL HEIGHT "B"	MAXIMUM PANEL THICKNESS	HOLE DIAMETER
1/8"	2034	.460"	.420"	.125"	.375"
3/16"	2047	.470"	.440"	.125"	.437"
1/4"	2057	.560"	.440"	.125"	.500"

Material: Nylon

Certifications: #E-15331
 # LR-8919

Flammability Rating: 94V-2

THREADED INSULATING BUSHINGS

- Converts raw edge pipe ends with NPT threading to smooth insulated ends.

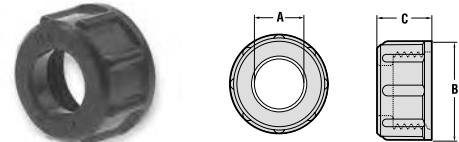

PART NUMBER	DIMENSIONS			MOUNTING
BLACK	INSIDE DIAMETER "A"	HEAD DIAMETER "B"	OVERALL HEIGHT "C"	NPT TRADE SIZE
2282	.268"	.530"	.296"	1/8"
2284	.348"	.715"	.363"	1/4"
2286	.468"	.875"	.466"	3/8"

Material: Nylon (2282)
Phenolic (2284, 2286)

WIRE MANAGEMENT BUSHINGS

LIQUID TIGHT BUSHINGS

CABLE DIAMETER RANGE	"Snap-In" Liquid Tight Grommets GRAY	DIMENSIONS			MOUNTING	
		HEAD DIAMETER "D"	HEAD THICKNESS "H"	OVERALL LENGTH "L"	HOLE DIAMETER	PANEL THICKNESS RANGE
.12" - .20"	4014	.79"	.27"	.50"	.52"	.040" - .160"
.20" - .28"	4015	.79"	.23"	.79"	.63"	.040" - .160"
.28" - .39"	4016	.94"	.23"	.83"	.75"	.040" - .160"
.39" - .55"	4017	1.02"	.25"	.93"	.91"	.040" - .160"
.55" - .79"	4018	1.34"	.26"	1.02"	1.14"	.040" - .160"
.79" - 1.02"	4019	1.81"	.27"	1.18"	1.50"	.040" - .160"
1.02" - 1.38"	4020	2.26"	.31"	1.42"	1.89"	.040" - .160"

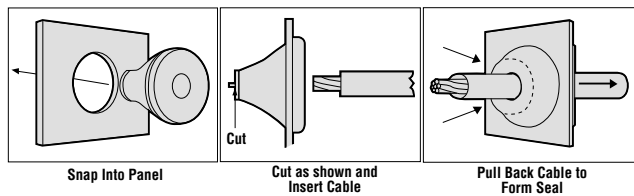

Installation

- Provides light strain relief to the cable.
- Simple to install; snap in panel, pierce membrane, pull cable through.
- Can also be used as liquid tight plug.

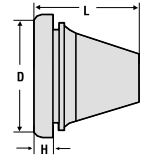

Material: Neoprene, Gray
Certifications: Fire tested to FMVSS 302, Vehicle Safety Norm 302 Protection Class IP 67 per EN 60529

Material: Nylon **Flammability Rating:** 94HB

FLEXIBLE GROMMETTING

PART NUMBER		DIMENSIONS			MOUNTING
BLACK	NATURAL	THICKNESS "A"	OUTSIDE DEPTH "B"	INSIDE WIDTH "C"	MAXIMUM PANEL THICKNESS
2220	2221	.032"	.125"	.031"	.036"
2222	2223	.032"	.173"	.109"	.071"
2224	2225	.032"	.173"	.109"	.105"
2226	2227	.047"	.189"	.156"	.164"
2228	2229	.047"	.189"	.187"	.187"
2230	2231	.047"	.189"	.250"	.250"

- Protects and insulates wires from sharp panel edges.
- Serrated design is ideal for irregular hole shapes.
- Grommeting grips panel edge. Epoxy can be added for additional grip strength.

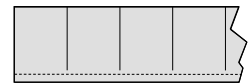
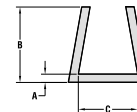

Clancey offers a full line of grommets and bushings made from rubber compounds. Please call for samples or information.